

# Internet Radio with FM/DAB/DAB+/FM

## Tuner

# A570+

## User Manual



Thank you very much for buying the A570+. In order to let you freely operate the product and fully enjoy the overbalancing happiness it brings you, we have introduced each function of the player in detail in this user manual. Please carefully read this user manual before use and keep for future reference.

## **Table of Contents**

1. Network Requirement
2. Safety Precaution
3. Appearance and Key Description
4. Getting Started
5. A570+ Functions
  - 5.1 Main Menu
  - 5.2 System Settings
  - 5.3 Internet Radio
  - 5.4 Spotify Connect
  - 5.5 Music Player
  - 5.6 DMR (DLNA streaming)
  - 5.7 DAB
  - 5.8 FM
  - 5.9 Bluetooth
  - 5.10 Sleep
  - 5.11 Alarm
  - 5.12 Extra Features
6. Troubleshooting
7. Specifications

# 1. Network Requirement

- A broadband connection in combination with a wired/wireless access point, router or similar network device.
- The network device needs to support Ethernet (LAN) wired connection or WiFi (802.11 b/g/n) wireless connection.
- PC, tablet or smartphone with network connected. This network has to be the same one as the NOXON NOVA II equipped with.

# 2. Safety Precaution

## General

- Do not drop the NOXON NOVA II and do not expose it to liquid, moisture or humidity. These might lead to damage to the device.
- If the NOXON NOVA II is moved from a cold environment into a warmer one, do let it adapt to the new temperature before operate the device. Otherwise, it might lead to condensation and cause malfunctions in the device.
- Do not use the NOXON NOVA II in the dust environment as dust can damage the interior electronic components and lead to malfunctions in the device.
- Protect the NOXON NOVA II from strong vibrations and place it on stable surfaces.
- Do not attempt to disassembly the NOXON NOVA II.
- If the NOXON NOVA II is not using for a long period of time, disconnect it from the power supply by unplugging the power plug. This is to avoid the risk of fire.
- The ventilation should not be impeded by covering the ventilation openings with items, such as newspapers, table-cloths, curtains, etc.
- No naked flame sources, such as lighted candles, should be placed on the apparatus.
- To maintain the compliance with the WiFi RF exposure requirement, place the product at least 20 cm (8 inches) from nearby persons except when operating the controls.

## Power adaptor

- Only use the power adaptor delivered with the NOXON NOVA II
- The socket outlet should be installed near the NOXON NOVA II should be easily accessible.
- Never touch the power plug with wet hands and never pull on



II.  
and  
the

- power cable when pulling the plug out of the power socket.
- Make sure the electrical voltage specified on the NOXON NOVA II and its power plug is corresponding to the voltage of the power socket. Incorrect voltage will destroy the device.



## Risks associated with high volumes

- While listening the NOXON NOVA II with headphones, always reduce the volume before put on the headphones. After the headphones are positioned properly, increase the volume to



the desired level.

- To prevent possible hearing damage, do not listen at high volume for long periods.

## Maintenance / cleaning

- Always power off the NOXON NOVA II when cleaning it.
- Never use any harsh or strong solvents to clean the NOXON NOVA II since these may damage the surface of the device. Dry, soft cloth is appropriate, however, if the NOXON NOVA II is extremely dirty, it may be wiped off with a slightly moist cloth. Make sure the device is dried off after cleaning.
- When you are necessary to ship the NOXON NOVA II, store it in its original package. Save the package for this purpose.

## Disposal

- If have to dispose the device in the future, note that all electrical and electronic device must be disposed of separately from household waste at official disposal centers. Avoid damage to the environment and risks to your personal health by disposing of device properly. For further information about proper disposal, contact your local government, disposal bodies or the shop where you bought the device. Dispose of all packaging in an environmentally -friendly manner. Cardboard packaging can be taken to paper recycling containers or public collection points for recycling. Any film or plastic contained in the packaging should be taken to your public .collection points for disposal. Respect the environment. Old batteries must not be disposed of with domestic waste. They must be handed in at a collection point for waste batteries. Please note that batteries must be disposed of fully discharged at appropriate collection points for old batteries. If disposing of batteries which are not fully discharged, take precautions to prevent short circuits.



### 3. Appearance and Key Descriptions

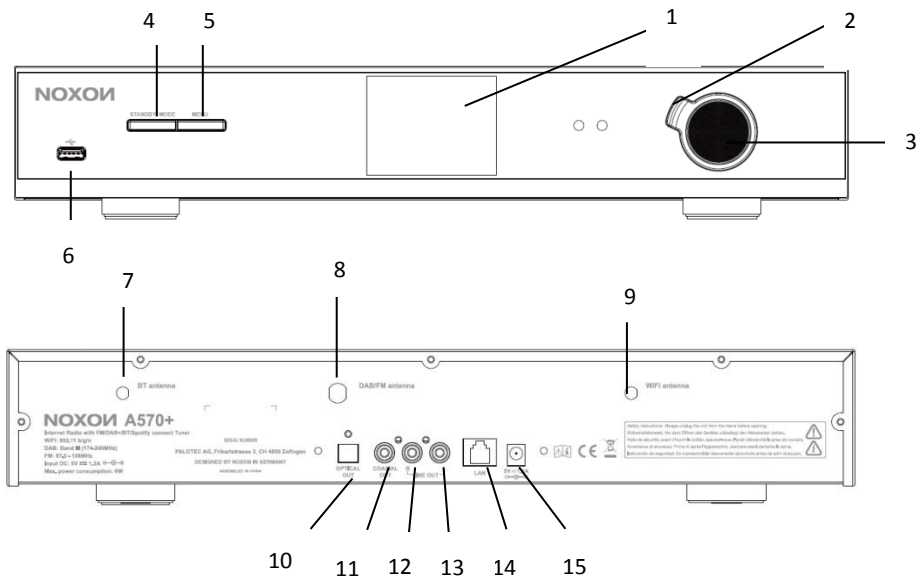

No.	Description	Functions
1	3.2" TFT Color Screen	Display
2	Back button	Basic control of operation
3	Reel	Basic control of operation
4	STANDBY/MODE Button	Basic control of operation
5	Menu Button	Basic control of operation
6	USB port	USB playback
7	BT Antenna	Strengthen the BT receiver
8	DAB/FM Antenna	Strengthen the DAB/FM receiver
9	WiFi Antenna	Strengthen the WiFi receiver
10	Optical Out	SPDIF Optical digital output
11	Coaxial Out	SPDIF Coaxial digital output
12	Line Out-R	3.5mm jack for speaker connection – Right channel
13	Line Out-L	3.5mm jack for speaker connection –Left channel
14	LAN port	Ethernet connection
15	DC IN	Power supply

### Remote Controller



Use your thumb to press the lid of the battery compartment and pull it out. Install a CR2025 type 3V battery into the battery compartment, taking care to insert it with the positive (+) side up.



Risk of explosion if battery is replaced by an incorrect type.  
Dispose of used batteries according to the instructions.

## WARNING

Do not ingest the battery, Chemical Burn Hazard

(The remote control supplied with) This product contains a coin/button cell battery. If the coin/button cell battery is swallowed, it can cause severe internal burns in just 2 hours and can lead to death.

Keep new and used batteries away from children.

If the battery compartment does not close securely, stop using the product and keep it away from children.

If you think batteries might have been swallowed or placed inside any part of the body, seek immediate medical attention.

## Suggestion:

- Never attempt to recharge or open the battery. Explosion hazard.
- Never damage or warp the battery.
- Never throw batteries into an open fire or expose them to high temperatures.
- Failure to observe these guidelines may cause fluid to escape from the battery, which can cause skin irritation.

In case of contact:

- Wash off the fluid with plenty of clear water
- Do not rub your eyes. Instead, rinse eyes with plenty of water for 10 minutes and seek immediate medical attention.
- Only use batteries of the same or an equivalent type. Explosion hazard.
- Remove the batteries from the battery compartment as soon as they are empty, or if you do not intend to use the device for a long period of time.

- If the battery compartment does not close securely, stop using the product and attention should be drawn to the environmental aspects of battery disposal.

## 4. Getting Started

The items enclosed in the packaging box are as follows:

- A570+ unit
- Power adaptor
- Remote control
- RCA Audio cable(RCA to RCA)
- FM/DAB pigtail antenna
- User manual

Connect the FM antenna and WiFi antenna to the back of A570+.

And connect the RCA audio cable to the Line out jacks of A570+ and your own speaker.

Then connect the power adaptor to the back of A570+ and plug it into power socket. (Turn on your own speaker if need audio out.)

Get the network environment ready

- *For wired Ethernet*  
Use an Ethernet cable (RJ45 jack) to connect the LAN ports on A570+ and your network device. Check if the light indicators on the network device are in appropriate status.
- *For wireless WiFi*  
Make sure you have setup the wireless network and you have the WEP, WPA or WPA2 security password to activate the connection.  
You may also use the WPS (WiFi Protected Setup) function for easy pairing between the network device and A570+. Check if the light indicators on the network device are in appropriate status.

Switch it on from A570+.



At the first time operation, system asks if you want to start the Setup Wizard. Select **YES** to continue the setup. Details of the Setup Wizard can be referred to Section 5.2.1 below. After choosing **NO**, the next screen asks if you would like to run the wizard next time A570+ is started.

A570+ will automatically connect to the network that was set before when power on to

Internet Radio again. In case you desire to change the network, enter **System Setting** to configure the corresponding connection. Refer to Section 5.2.1 and 5.2.3.

Press and hold **STANDBY/MODE** on the device or press  on the remote control to enter standby mode. The time, date and any active alarm times display on the screen.

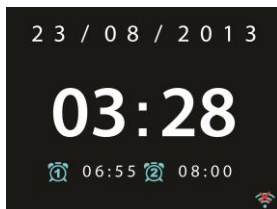

Rotate the volume reel or press  /  on the remote control to adjust the volume. Rotate the volume reel or press  until volume level becomes 0, or direct press  to mute the sound.

#### Music Sharing from PC

- To share the music files from PC, the following steps are done on the PC:
  - Connect the PC to the network.
  - Ensure A570+ is powered on and connected to the same network.
  - Open the UPnP platform **Windows Media Player** (11 or later). Alternatively, other platforms or server such as **Windows Media Connection** may be used.



- Allow to share your media to **A570+**, which is the device name for music streaming.

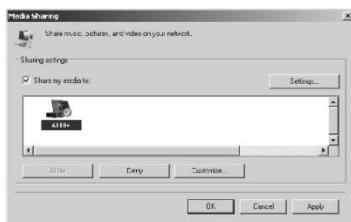



- Add the audio files and folders you want to share with A570+ to the media library.

## 5. A570+ Functions

### 5.1 Main Menu

Under the main menu, you can select the following modes: Internet Radio, Spotify Connect, Media Player, DAB, FM, Bluetooth, Sleep and Alarm. Alternatively, press **STANDBY/MODE** on the device or **MODE** on the remote control to enter main page, move to the mode by rotating the reel or press ◀ / ▶ on the remote control.

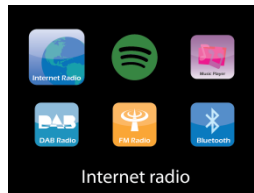

### 5.2 System Settings

#### 5.2.1 Setup Wizard

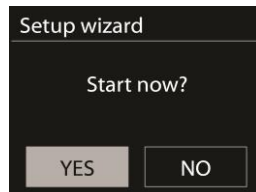

- Time/date  
*Display format*  
Select 12 or 24 as the time format.

#### *Auto-update*

The time and date can be updated manually or automatically from DAB, FM or network.

Auto-update works with data sent over DAB, FM or the Internet. The clock is only updated when in a corresponding mode, so it is best to select a mode you use regularly.

DAB and FM use time signals broadcast with radio transmissions. Network uses a time signal sent from the Internet radio portal when in any network-connected mode.

### *Time zone, daylight*

Set your time zone. If your country uses daylight saving and it is in effect, turn on the Daylight savings option.

### *Manual update*

If you set No update, the wizard prompts you to set the time and date manually. The date and time are displayed as dd-mm-yyyy and hh:mm.

The active value appears as flashing. Adjust each value to press ◀ / ▶ on the remote control. Once the value is set, press **OK** to continue setting with next value.

- Network

### *Wlan region*

Select the Wlan region to obtain the optimal Wlan connectivity: Canada, Spain, France, Japan, Singapore, Australia, and Republic of Korea.

### *Scanning for the network*

A570+ is compatible with all common network protocols and encryption methods. It searches for the available networks and list them out for you choose.

There will be hints for the type of network – if you plug the LAN cable, it will show one network of **[wired]**; if your network device supports WPS function, it will be **[WPS]** before the SSID (the name of network device). Select the one you want to connect.

For the wireless connection, you will be asked for input encryption in the next step.

### *Standard encrypted network*



To enter the network's key, use the navigate reel or direction keys on the remote control to move the cursor through the characters and press **OK** to confirm. As each character is selected, the key is built up near the top of the display.

There are three options accessible by tuning the navigate reel back before the first characters – Backspace, OK and Cancel.

## WPS encrypted network

WPS encrypted networks are identified by **WPS** at the start of the network name when the A570+ searches the available AP. Use one of the following methods of connection:

- Push button

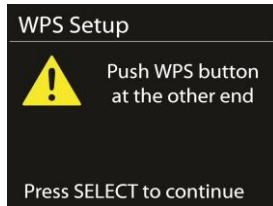

A570+ prompts you to press the connect button on the router. It then scans for a ready Push Button Connect network and connects.

- Pin

A570+ generates an 8-digit code number which you enter into the wireless router, access point, or an external registrar.

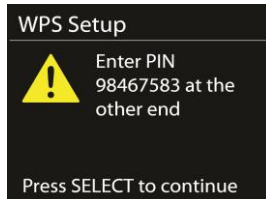

- Skip WPS

Enter key as for a standard encrypted network.

For more information on setting up a WPS encrypted network, see your WPS router's instructions.

- Completion

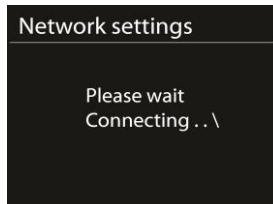

A570+ attempts to connect to the selected network.



It will show connected if the setup is successful. If connecting fails, A570+ returns to a previous screen to try again.



Press **OK** to quit the setup wizard.

## 5.2.2 Equaliser

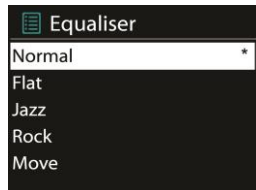

Several preset EQ modes are available: Normal, Flat, Jazz, Rock, Movie, Classic, Pop and News.

Also a user-defined setting is available; create your own EQ with custom bass, treble and loudness settings.

Press **EQ** on the remote control to quick enter equalizer menu.

## 5.2.3 Network

- Network wizard
  - Enter to search AP SSID, then input the WEP / WPA key or choose Push Button/Pin/Skip WPS to connect to the wireless network.
- PBC Wlan setup
  - Push Button Configuration, it is to connect the AP that supports WPS (Wi-Fi Protected Setup).
- View settings
  - View the information of current connected network: Active

connection, MAC address, Wlan region, DHCP, SSID, IP address, Subnet mask, Gateway address, Primary DNS and Secondary DNS.

- **Wlan region**  
Select the Wlan region to obtain the optimal Wlan connectivity: Canada, Spain, France, Japan, Singapore, Australia, and Republic of Korea.
- **Manual settings**  
Choose wired or wireless network connection and enable or disable DHCP (Dynamic Host Configuration Protocol).
- **Network profile**  
A570+ remembers the last four wireless networks it has connected to, and automatically tries to connect to whichever one of them it can find.  
From here you can see the list of registered networks. You can delete unwanted networks by turning and pressing **OK** then choosing YES to confirm delete.
- **Keep network connected**

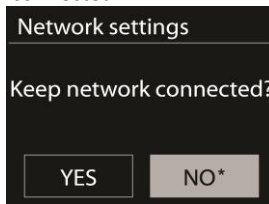

If you choose to keep network connected, the WiFi will not disconnect even you are in standby mode. Otherwise, the connection will only available. This option allows A570+ to be ready for DLNA streaming in any operating modes. Details for DLNA streaming, refer to Section 5.6.

#### 5.2.4 Time/Date

Set the time manually or auto update, time format, time zone and daylight.

#### 5.2.5 Language

The default language is English. Change it as your preference.

#### 5.2.6 Factory reset

A factory reset resets all user settings to default values, so that time and date, network configuration and presets are lost. However, the A570+'s current software version is maintained, as is registration with the Internet radio portal. Internet radio favourites therefore remain unless you re-register your A570+ with another account on the portal website.

#### 5.2.7 Software update

From time to time, software upgrades may be created with bug fixes and/or

additional features. You can either check manually or set A570+ to check periodically automatically (this is the default). If newer available software is detected, you will be asked if you want to go ahead with an update. If you agree, the new software is then downloaded and installed. After a software upgrade, all user settings are maintained.

**NOTE:** Before starting a software upgrade, ensure that A570+ is plugged into a stable main power connection. Disconnecting power during an upgrade may permanently damage the unit.

#### 5.2.8 Info

View the firmware version and the radio ID.

#### 5.2.9 Backlight

You may change the backlight of each environment (power on or standby) to High, Medium or Low. And adjust the timeout duration which the radio turns to standby backlight level when it has not been controlled.

#### 5.2.10 Standby Clock Format

You may change the Standby Clock format to Analog or Digital.

### 5.3 Internet Radio

A570+ can play thousands of radio stations and podcasts from around the world though a broadband Internet connection.

When you select Internet radio, A570+ directly contacts the Frontier Silicon Internet radio portal (which is supported by v-tuner) to get a list of stations.

The portal also enables multiple lists of favourite stations that you can personalize.



If you are already listening to an Internet radio station, you can press  to quickly return to the last visited branch of the menu tree, rather than MENU to go to the first menu of Internet radio mode.

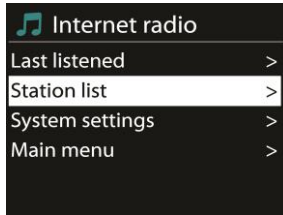

### 5.3.1 Last listened

When Internet radio mode restarts, the last-listened station is selected. To select another recently used station, enter here to select the listed station. Most recent stations appear at the top of the list.

### 5.3.2 Station list

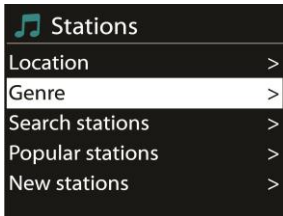

Browse Internet broadcasts that organized into different categories, Location, Genre, Popular and New. You can also find the station with Search by keyword.

### 5.3.3 Favourites

Favourites are stored with the Internet radio portal, and are available through all Internet radios registered on the same account. Before favourites can be used, the radio has to be registered with the Internet radio portal.

To register your A570+, choose Station list > Help > Get access code to get your radio's unique portal access code first. (Do not confuse the portal access code with the Radio ID from System settings.

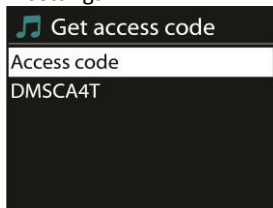

Visit the portal website at [www.wifiradio-frontier.com](http://www.wifiradio-frontier.com)

If this is your first visit to the portal, register for a new account, entering the following information:

- access code,
- your e-mail address,
- password,
- radio model.

If you already have an account and wish to add an additional radio, log in to your account and select My preferences > Add another Wi-Fi radio.

Once your radio is registered with the portal, you can immediately use the Internet radio favourites and added stations features.

To store a playing station as a favourite, press and hold **OK** until the display shows 'Favourite added'. The station appears in the default favourites list Stations.



#### 5.3.4 My added stations

Even though the Internet radio portal contains thousands of stations, you may want to listen to stations not listed. You can add your own via the portal.

#### 5.3.5 Presets

Presets are stored in the radio and cannot be accessed from other radios.

To store an Internet radio preset, press and hold  on the remote control until the display shows the Save preset screen. Select one of the 10 presets to save the current station.

To select a preset, press the number key, then the selected preset station will be played. When a preset station is playing, it shows  *n* (  1,  2 etc) at the bottom of the screen.

"1" to "0" on the remote control are for the use of preset station 1-10.

#### 5.3.6 Now playing information

While the stream is playing, the screen shows its name and description. To view further information, press **INFO**.

Each time you press **INFO**, another set of information is displayed, cycle through name/description, genre/location, reliability, codec/sampling rate, playback buffer and today's date.

### 5.4.1 Spotify Connect

#### Using This Device With Spotify Connect

##### A better way to listen at home

Spotify Connect lets you play Spotify through your home speakers or TV, using the Spotify app as remote.

You'll need Spotify Premium to use Connect – see details overleaf.

**Step 1.** Add your device to your wifi network (see product user instructions for details).



**Step 2.** Fire up the Spotify app on your phone, tablet or PC using the same wifi network as above.

**Step 3.** Play a song on Spotify and hit 'DEVICES AVAILABLE'.

**Step 4.** Choose your device and your music will start playing out loud.

For more information on how to set up and use Spotify Connect please visit [www.spotify.com/connect](http://www.spotify.com/connect)

## Licenses



The Spotify Software is subject to third party licenses found here:



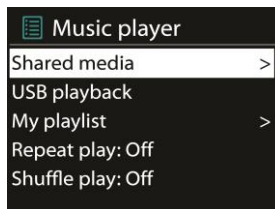

<http://www.spotify.com/connect/third-party-licenses>

## 5.5 Media Player

Music player mode plays audio files in MP3, WMA, WAV, AAC or FLAC format from a computer on the local network.



If you are already playing a music file, you can press  on the remote control rather than  or MENU to quickly return to the last visited branch of the menu tree.

You can use  or  to play the previous or next track, press and hold to rewind or fast forward. Press and hold to rewind or fast forward (x1, x2, x4). Press  on the remote control to play or pause. Press  on the remote control to stop playback and return to the music list.

### 5.5.1 Shared media

If you have set up shared media, you should see an entry consisting of <computer name>: <Shared media name>. If you have more than one computer sharing media, the alternatives are listed. Select the shared media you want to play.

From this point on, the menus are generated from the shared media server. The first menu shows a list of media types, for example Music, Video, Pictures and Playlists. A570+ can only play music and playlists.



There is also a search function which finds tracks in a similar way to Internet radio search.

From Music, there are numerous ways of selecting tracks including Genre, Artist, Album, Composer and Rating.



Once you have found a track you want to play, press **OK**. A short press plays the track immediately.

### 5.5.2 Repeat/shuffle

You can set to repeat tracks or play them in random order. Press **REPEAT/RANDOM** on the remote control to turn on/off the repeat function.

Press and hold **REPEAT/RANDOM** to turn on/off the random function.

### 5.5.3 Now playing information

While a track is playing, the screen shows its track and artist (UPnP). There is also a progress bar with figures for elapsed and total track time. At the bottom of the screen, an icon indicates UPnP depending on the source. To view further information, press **INFO**.

Each time you press **INFO**, another set of information is displayed, cycling through the information:





UPnP: track/artist/progress bar/track times, album, codec/sampling rate, playback buffer and today's date.

### 5.5.4 USB playback

From this point on, menus are generated from the folders on the USB device. Browse folders with direction keys on the remote control. The display shows folder and file names (not necessarily track names).

Once you have found a track you want to play, press **OK** on the remote control. A short

press plays the track immediately.

You can use  or  to play the previous or next track, press and hold to rewind or fast forward (x1, x2, x4). Press  on the remote control to play or pause. Press  on the remote control to stop playback and return to the music list.

The USB port is just for music playback, no charging function.

## 5.6 DMR (DLNA Streaming)



Shared music in Section 5.5.1 is a way of music streaming which you look for the music list and control playback from A570+. This topic will introduce another way to do the music streaming which is not necessary to control playback on A570+.

You can share the music files from PC, Android mobile or tablet, and directly use your PC, Android mobile, tablet or iPhone / iPad to control music playback on the A570+. It is simple called DLNA streaming.

### 5.6.1 Control on PC

The PC system requirements for DLNA are **Windows 7** and **Windows Media Player 12**. Setup as below:

Firstly, share the media on your PC to A570+.

**Control Panel > Network and Internet > Network and Sharing Center > Media streaming options**



Open **Windows Media Player** to enable **Allow remote control of my Player**.

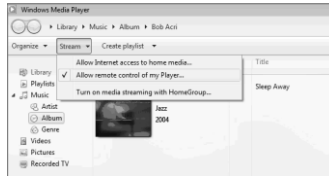

Right click any music in the library and choose Play to **A570+**.



A box of music playback pops up for the streaming.

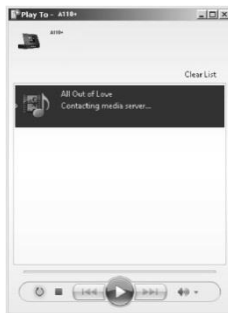

## 5.6.2 Control on Smartphone / Tablet

You may search (with keyword: **DLNA**) and install any free or commercial DLNA Apps from **Google Play** or **Apple Store** if you are using Android mobile, tablet or iPhone / iPad.

It is suggested to use **iMediaShare** on Android mobile, tablet or iPhone/iPad.

Procedures for playing shared music on the app are as follows:

1. Select **A570+** as the player.
2. Select music server and choose the music.

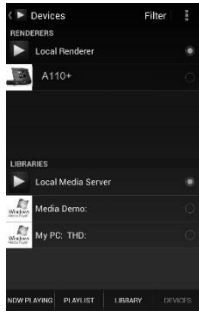

Select player

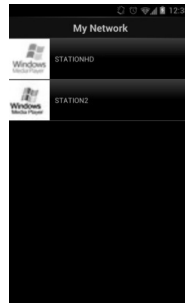

Select server

**NOTE:** Some Apps may not support streaming music from iPhone/iPod but iPhone/iPod could still be used to control streaming music from other servers.  
 Some Apps may allow to play the music to multi players at the same time.  
 Some Apps can create a playlist if you choose several music.  
 Study the own instruction of the software or Apps you use to enjoy DLNA streaming if necessary.

## 5.7 DAB

DAB mode receives DAB/DAB+ digital radio and displays information about the station, stream and track playing.



### 5.7.1 Scanning for stations

The first time you select DAB radio mode, or if the station list is empty, A570+ automatically performs a full scan to see what stations are available. You may also need to start a scan manually to update the list of stations for one of the following reasons:

- Available stations change from time to time.
- If reception was not good for the original scan, this may result in an empty or incomplete list of available stations.
- If you have poor reception of some stations (burbling), you may wish to list only stations with good signal strength.

To start a scan manually, choose Full scan. To scan only stations with good signal strength, select Local scan.





Once the scan is complete, the radio shows a list of available stations.

To remove stations that are listed but not unavailable, choose Prune invalid.

Turn the navigate reel to view a list of stations and press to select. Once selected, the station plays and the screen shows information about station, track or show as broadcast.

### 5.7.2 Presets

To store a DAB+ preset, press and hold  on the remote control until the display shows the Save preset screen. Select one of the 10 presets to save the current station.

To select a preset, press  briefly, then select one of the listed preset stations.

When a preset station is playing, it shows   $n$  ( 1,  2 etc) at the bottom right of the screen.

"1" to "0" on the remote control are for the use of preset station 1-10.

### 5.7.3 Now playing information

While the stream is playing, the screen shows its name and DLS (Dynamic Label Segment) information broadcast by the station giving real-time information such as programme name, track title and contact details. Stereo broadcasts are indicated with an icon at the top of the screen. To view further information, press **INFO**.

Each time you press **INFO**, another set of information is displayed, cycling through DLS text, programme type, ensemble name/frequency, signal strength/error rate, bit rate/codec/channels and today's date.

### 5.7.4 Settings

- **Dynamic range compression (DRC)**  
If you are listening to music with a high dynamic range in a noisy environment, you may wish to compress the audio dynamic range. This makes quiet sounds louder, and loud sounds quieter. You can change DRC as off, low or high.
- **Station order**  
You can choose the order of the DAB station list to be either Alphanumeric, Ensemble or Valid.

Ensemble lists groups of stations that are broadcast together on the same ensemble. Valid lists valid stations first, alphanumerically, then off-air stations.

## 5.8 FM

FM radio mode receives analogue radio from the FM band and displays RDS (Radio Data System) information about the station and where broadcast.

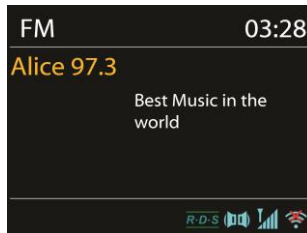

To find a station, press **OK**. The frequency display starts to run up as A570+ scans the FM band. Alternatively, you can scan up or down by pressing and holding ◀ / ▶ with quick presses.

### 5.8.1 Preset

To store a FM preset, press and hold ★ on the remote control until the display shows the Save preset screen. Select one of the 10 presets to save the current station.

To select a preset, press ★ briefly, then select one of the listed preset stations.

When a preset station is playing, it shows ★ n (★ 1, ★ 2 etc) at the bottom right of the screen.

“1” to “0” on the remote control are for the use of preset station 1-10.

### 5.8.2 Now playing information

While the stream is playing, the screen shows its frequency, or if RDS information is available, station name and any further RDS information such as programme name, track title and contact details. If no information is available, just the frequency is shown. Stereo broadcasts are indicated with an icon at the top of the screen, To view further information about the broadcast, press **INFO**.

Each time you press **INFO**, another set of information is displayed, cycling through RDS text, further RDS text (station/programme type), frequency and today's date.

### 5.8.3 Settings

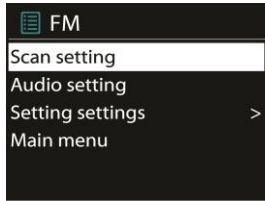



- **Scan settings**  
By default, FM scans stop at any available station. This may result in a poor signal-to-noise ratio (hiss) from weak stations. To change the scan settings to stop only at stations with good signal strength, select Yes after choosing Strong station only?
- **Audio settings**  
All stereo stations are reproduced in stereo. For weak stations, this may result in a poor signal-to-noise ratio (hiss). To play weak stations in mono, select FM weak reception: Listen in mono only and then YES.

## 5.9 Bluetooth

When you select the Bluetooth mode, the device is entering to pairing and the BT icon at the bottom of the screen will flash. Turn on your smartphone, tablet or other Bluetooth devices to search for the device. The Bluetooth pairing name is "A570+". When pairing is successful, the Bluetooth indicator will light up and stop flashing.

To release the Bluetooth pairing, press and hold  on the remote control.



Press  on the remote control to play or pause the music. You can also press  or  on the remote control to play the previous or next track.

## 5.10 Sleep

To set the sleep timer, select Sleep in the Main menu or press SLEEP/SNOOZE on the remote control. Choose sleep period option from Sleep OFF, 15 MINS, 30 MINS, 45 MINS or 60 MINS.

Once you select a sleep period, the system returns to the main menu. Press MENU on the device or  on the remote control to return to the Now playing screen.



## 5.11 Alarm

There are two versatile wake-up alarms with snooze facility, and a sleep function to turn the system off after a set period. Each alarm can be set to start in a particular mode.

Select Alarms under Main menu to set or change an alarm.



Select the alarm number (1 or 2) then configure the following parameters:

- Enable: on/off,
- Frequency: Daily, Once, Weekends or Weekdays,
- Time,
- Mode: Buzzer, Internet Radio, DAB or FM,
- Preset: Last listened 1-10,
- Volume: 0-20

To activate the new settings, scroll down and select Save.

The screen shows active alarms with an icon at the bottom left.

At the set time, the alarm will sound. To temporarily silence, press any button on the remote control. You can change the snooze period. The radio returns to standby for the set period, with the silenced alarm icon flashing.

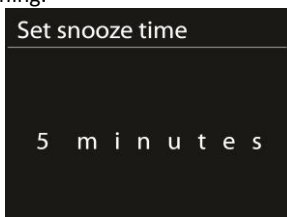

## 5.12 Extra Features

### 5.12.1 Headphone jack

A570+ featured with headphone jack for you to continue enjoying the music in vary environments, such as noisy background, or the area that requires every one keeping silent.

It is recommended to reduce the volume before put on the headphones. After the headphones are positioned properly, increase the volume to the desired

level.

### 5.12.2 RCA out socket

It allows you to connect a RCA cable from A570+ to your own HiFi speaker system to enhance sound performance.

### 5.12.3 Coaxial output socket

It allows you to connect an audio cable from A570+ to your own HiFi speaker system to enhance sound performance.

### 5.12.4 Optical Output

It allows you to connect an optical cable from A570+ to your own HiFi speaker system to enhance sound performance.

### 5.12.5 NetRemote (UNDOK)

The device gives a feature of NetRemote by smartphone or tablet in iOS or Android system. By downloading the assigned app named UNDOK, you can view all the modes of Internet Radio, Spotify Connect, Music Player, DAB, FM and AUX IN.

Search UNDOK from **Google Play** or **Apple Store**, and install it to your smartphone or tablet.



Before using the UNDOK app, make sure the device and the smartphone / tablet are in the same WiFi network.

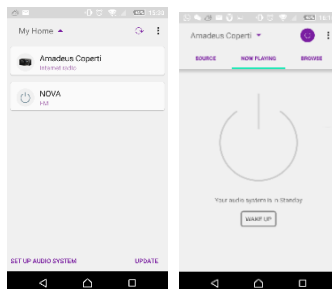

Launch the app. The app initializes and scans for Internet Radio in the network. Tap Internet Radio to make the connection of NetRemote.





Once the smartphone / tablet has accessed to the device, they will be automatically connected next time when you open the app again.

Select your desired mode in the main page. You may then control the selected

mode on your smartphone / tablet and on the display of the device simultaneously.

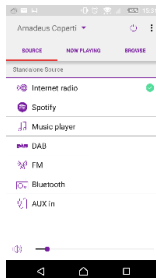
Tap  to go to the standby mode. Tap again  or “wake up” to go to operation mode.



Tap "Browse" to view the details. Tap  to view the saved preset stations, and tap (+) to add the playing station to the desired preset station number.

- Internet Radio

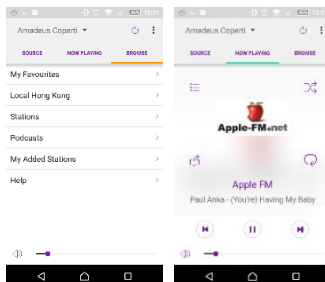

Browse the station list, choose station and view the station rolling text from the app.

- Spotify Connect (Refer to section 5.4)

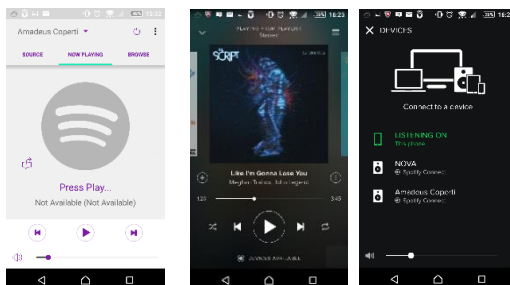

Go to Spotify app to choose the music from your Spotify playlist.

Tap the Spotify icon on the Spotify app, then choose the preferred device (NOXON NOVA II). It should be displayed in the Spotify app. Once selected, music will be streaming to the device.

- **Music Player**



Browse the music files from shared media, choose music from the app.

- **DAB**

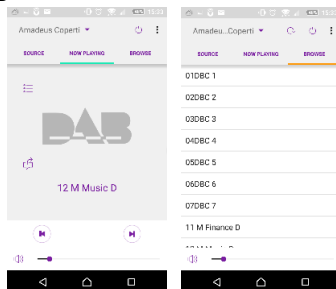

Browse the scanned DAB+ stations, choose the station and view the rolling text of station from the app.

- **FM**

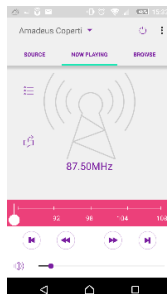

Manual search or scan the stations from the app.

From the app, you can also control to operate **STANDBY/ON**, **EQUALIZER**, **CHANGE PIN** and **RENAME** of the device under **SETTING** menu  
 For **CHANGE PIN** setting, please also refer to Section 5.2.3.

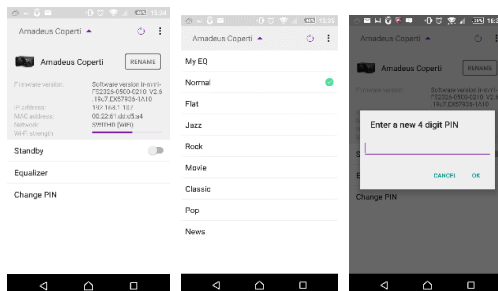

RadioVIS is a channel for broadcasters to deliver Slideshows over the Internet. RadioVIS Slideshows appear like the DAB+ slideshows, they are closely associated with the broadcasted audio service. However it is only available in some countries around the world. (Visit [radioDNS.org](http://radioDNS.org) for more details about their broadcasts.)

Once RadioVIS is enabled in the app, and the slideshows are available, the slideshows will be shown from Now Playing display in the DAB mode or FM mode on the NetRemote app.

**NOTE:** Be aware that if another smartphone / tablet with the app in the same network have access with the device, the original connection will be cut off.

## 6. Troubleshooting

Error	Remedy
The device does not switch on.	Check it the power adaptor is connected properly.
No sound.	<ol style="list-style-type: none"> <li>1. Turn on the sound as it may be muted</li> <li>2. Increase the volume.</li> <li>3. Pull any connected headphone or speaker from the connector jack.</li> </ol>
No network connection can be established.	<ol style="list-style-type: none"> <li>1. Check the LAN cable or the WLAN function.</li> <li>2. Try to set an IP address at the device.</li> <li>3. Activate the DHCP function on the router and make the connection again at the device.</li> </ol>

	<ol style="list-style-type: none"> <li>4. A firewall is activated on the network – set the respective program in such a way that access is possible.</li> <li>5. Reboot the router</li> </ol>
WiFi connection cannot be established.	<ol style="list-style-type: none"> <li>1. Check the availability of WLAN network on the router.</li> <li>2. Place the device closer to the router.</li> <li>3. Make sure the password is correct.</li> </ol>
Wired connection cannot be established.	<ol style="list-style-type: none"> <li>1. Check the availability of LAN network on the access point.</li> <li>2. Reconnect or even replace the LAN cable.</li> </ol>
No station is found.	<ol style="list-style-type: none"> <li>1. Check the network as well as the access point and firewall.</li> <li>2. The station may not be available currently, try it again later or select another station.</li> <li>3. The link of the station is changed or the station no longer transmits – ask the provider for information.</li> <li>4. The link of manual added station is not correct, make sure it is correct and re-enter.</li> </ol>
Hiss in FM mode	<ol style="list-style-type: none"> <li>1. Check/move the FM antenna.</li> <li>2. Move the radio.</li> </ol>
No stations available / burbling / intermittent in DAB mode.	<ol style="list-style-type: none"> <li>1. Move the radio.</li> <li>2. Rescan local stations only (high-strength).</li> <li>3. Check the local DAB coverage.</li> </ol>
Alarm does not work.	<ol style="list-style-type: none"> <li>1. Switch on the alarm.</li> <li>2. Due to the volume setting, refer to the solutions of “No sound”.</li> <li>3. The source of alarm was set to be station but there is no network connection. Change the source of alarm or reconfigure the connection.</li> </ol>
USB driver or MP3 player is not detected.	<ol style="list-style-type: none"> <li>1. Check if the USB driver or MP3 player is plugged properly.</li> <li>2. Some USB hard disks need external power supply, make sure it is connected to the power.</li> <li>3. Not all MP3 players can be read directly on the device – use an USB drive instead.</li> </ol>
NetRemote does not show or connect to A570+	<ol style="list-style-type: none"> <li>1. Reopen the App.</li> <li>2. If you have several streaming from several devices at the same time, it may cause crash, reboot A570+ and/or your device.</li> </ol>
All other undetermined cases.	<p>A570+ may process large amount of data after a period of operation, no matter in which mode, it will cause the system freeze or malfunction. Reboot A570+ if necessary.</p> <p>The normal function of the product may be disturbed by strong Electro-Magnetic Interference. If so, simply reset the product to resume normal operation by following the instruction manual. In</p>

	case the function could not resume, please use the product in other location.
	The device may malfunction when used in areas with strong radio interference. The device will work properly again once there is no more interference.

## 7. Specification

<b>Model number</b>	A570+
Description	Internet radio with FM/DAB/DAB+/BT adaptor
Display	3.2", 320 x 240, TFT colour display
Network supported	IEEE 802.11b/g/n wireless (WiFi) 10/100 Ethernet (LAN)
Frequency band	WiFi : 2.400 - 2.4835 GHz Bluetooth: 2.4GHz - 2.48 GHz
Max. radio frequency power transmitted	WiFi: 17.432dBm Bluetooth: < 20dBm
Encrypted key	WEP, WPA, WPA2 (PSK), WPS
Streaming	UPnP, DLNA
Supported playback formats	MP3, WMA, WAV, AAC, FLAC
DAB / DAB+	Band III (170 – 240 MHz)
FM	87.5 – 108.0 MHz, with RDS
Power adaptor	5V 1200mA
Standby mode power consumption	<1W
Operating temperature	0 °C - 35 °C
Connections	USB port (music playback, no charging function) Earphone out socket Analog Stereo Output For RCA , Coaxial output , Optical Output LAN (RJ45) port DC IN power supply socket
Dimensions	160mm(L) x 112mm(H) x 101mm(D)
Weight	0.6 kg

*Specifications subject to change without notice.*

<b>Power Adaptor</b>	
Manufacturer	Guangdong Keerda Electronic Co. Ltd.
Type	DZ006HL050120V
Input	100 – 240V AC, 50/60 Hz
Output	5V 1200mA 

*Use only original AC adaptor*



*Use only the power supply listed in the user instructions*

This product operates under Wi-Fi mode at 2.412-2.472GHZ and is designated only to be used inside a normal household environment. This product is suited for this purpose within all EU countries.

***Specifications subject to change without notice.***



For information about CE Conformity and WEEE please visit our website.

### **Warranty terms**

The warranty period shall commence on the purchase date. Please keep your original receipt in a safe place. This is required as a proof of purchase.

If a material or production fault occurs in this product within 24 months of the purchase date, we shall – at our discretion – repair or replace the product free of charge.

This warranty requires that the defective device has to be sent to the service centre together with the original proof of purchase and a brief description of the fault within these 24 months. If the fault is covered by our warranty, you will receive the repaired product or a replacement device.

The warranty period shall not begin again if the product is repaired or replaced.

Processing of warranty claims

Contact our support (see our website). Have the serial number and the proof of purchase ready. Our support may already be able to solve the problem. If the problem cannot be solved, you will receive instructions on where to send the device to.

Manufacturer:

Palotec AG

Frikartstrasse 3

4800 Zofingen

Telefon: +41 62 508 26 26

Fax: +41 62 508 26 27

Web: [www.palotec.ch](http://www.palotec.ch)

E-Mail: [sales@palotec.ch](mailto:sales@palotec.ch)

Made in China